

Rain shower for surface-mounted ceiling installation with light 300 mm -  
Chrome

TARA

28 032 970















Fits: TARA, LISSÉ, VAIA, META

- rain shower Ø 300 mm
- PURE RAIN, max. flow rate 12 l/min (at 3 bar)
- PURIFY RAIN, max. flow rate 6 l/min (at 3 bar)
- Distance to ceiling from bottom edge of shower 40 mm
- with anti-scale system
- central LED Spot 3000 K
- Provided by customer: Light switch
- For simultaneous control of the jet types, we recommend the xTool thermostat module
- Not suitable for use in a steam room.

**includes light bulbs with a Class F energy efficiency**

includes light bulbs with a Class F energy efficiency

	Chrome	28 032 970-00
	Brushed Platinum	28 032 970-06
	Platinum	28 032 970-08
	Dark Chrome	28 032 970-19
	Light Gold	28 032 970-26
	Brushed Light Gold	28 032 970-27
	Brushed Durabrass (23kt Gold)	28 032 970-28
	Matte Black	28 032 970-33
	Brushed Bronze	28 032 970-42
	Brushed Champagne (22kt Gold)	28 032 970-46
	Champagne (22kt Gold)	28 032 970-47
	Brushed Chrome	28 032 970-93
	Brushed Dark Platinum	28 032 970-99

Required miscellaneous



**Concealed ceiling installation box** 35 042 970 90  
**for surface-mounted ceiling  
installation with light -**

- min. recess depth 90 mm
- max. recess depth 115 mm
- 2x female thread 1/2" connections
- Input 100-240V AC 50-60Hz
- concealed rough parts
- Output 350 mA SELV / Class II
- Provided by customer: Light switch

28 032 970  
mm [inches]

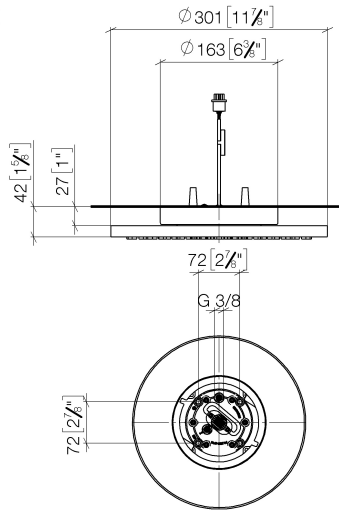

Flow rate chart

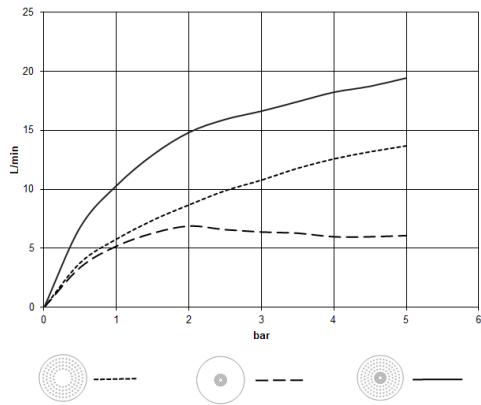

Certificates

LGA\_38400.

28 032 970



**Spare parts list**

No.	Item Number	Name	Quantity used	Delivery time
1	90 17 20 263 00 90	fixing set	1	2
2	90 24 03 309 01 90	connection	1	2
3	90 24 03 309 00 90	connection	1	2
4	90 10 01 225 00 90	electronic accessories	1	2